

BERT FRANK

FAROL PENDANT

MAINTENANCE

- Lacquered brass should be wiped with a soft duster.
- Do not clean with any liquid, chemical or abrasive cleaners.
- All electrical work must be conducted by a qualified electrician.

TECHNICAL

- 1 x G9 LED Bulb

www.bertfrank.co.uk
+44 (0)207 164 6482

INSTRUCTION

- 1**
- Feed electrical cable from ceiling through hole in mounting plate.
 - Fix mounting plate to ceiling using suitable fixings.

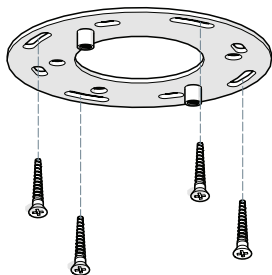

- 2**
- Make electrical connection using connector blocks.

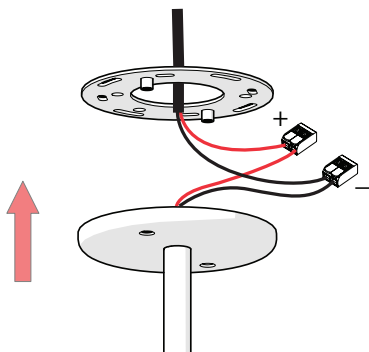

- 3**
- Secure ceiling rose cover to mounting plate using 2x screws.

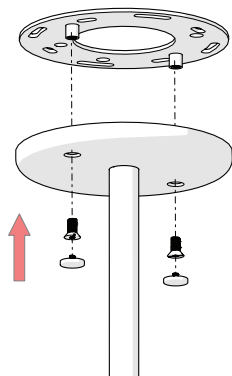

- 4**

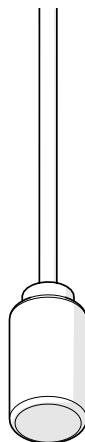

GLOBE REPLACEMENT INSTRUCTION

1 - Gently loosen and remove glass shade by turning

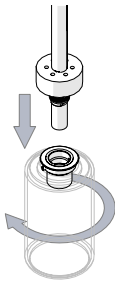

2 - Remove G9 bulb

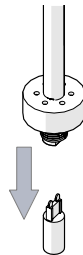

3 - Replace with LED only G9 bulb

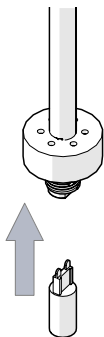

4 - Replace glass shade, being sure not to over tighten

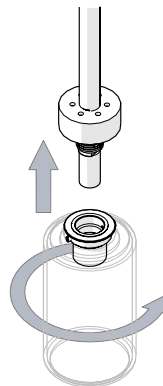

This product is only suitable for connection to the native power supply to which the unit was specifically manufactured. It is for indoor use only, and not suitable for a bathroom location.

If the Class II, double insulated symbol is on the lamp, it does not require an Earth, and Live or Neutral must not be connected to Earth. If there is no such symbol, then the lamp must be Earthed.

Under no circumstances must this lamp be covered with any material as this could pose a safety hazard. It must be used on a stable, flat surface.

Never fit bulbs of a higher wattage than those specified on the label, as these may cause overheating and damage the fitting. If the mains cable becomes damaged it must only be replaced by a technically competent, qualified person.

Allow 10 minutes to cool before replacing, adjusting or cleaning. Clean with specified cleaners only. Do not use other liquid, chemical or abrasive cleaners on this product.

If you are in any doubt about your competence please consult a qualified electrician. If any modification is made it will invalidate the warranty and may render the product unsafe.